

Technical Sheet

Renovent Sky 300 (Plus)



The Brink Renovent Sky 300 is a ventilation unit with heat recovery with an efficiency of 95%, a maximum ventilation capacity of 300 m³/h and low-energy fans.

Features Renovent Sky:

- steplessly adjustable air flow rates through a control unit (supplied with appliance).
- filter indication on the control unit / multiple switch.
- a completely new intelligent frost protection system which ensures that also at low outdoor temperatures the appliance's performance remains optimal and that, if necessary, it activates the optional preheater.
- low sound level
- comes as standard with automatic bypass valve
- constant flow control
- low energy consumption
- high efficiency

Renovent Sky 300 is available in two types:

- **“Renovent Sky 300”**
- **“Renovent Sky 300 Plus”**

Compared to the Renovent Sky 300, the Renovent Sky 300 Plus has a more extensive control board which increases the connection options.

These installation instructions describe both the standard Renovent Sky 300 and the Renovent Sky 300 Plus.

With the aid of the supplied mounting brackets, the Renovent Sky 300 (Plus) can be mounted either on the wall or on the ceiling. For the correct position of the connection ducts and dimensions see page 5.

When ordering an appliance always state the correct type; subsequent conversion to a different version is highly labour-intensive.





The Renovent Sky 300 comes ready to plug in with a 230 V mains plug.

The appliance comes as standard with a control unit, but connection of a simple 4-way switch is possible as well.

If a 4-way switch is installed instead of a control unit, the settings of the appliance can only be changed with a laptop!

Connecting a combination of control unit and multiple switch is another option.

Technical information

		Renovent Sky 300				
Supply voltage [V/Hz]	230/50					
Protection degree	IP30					
Dimensions (w x d x h) [mm]	1185 x 644 x 310					
Duct diameter [mm]	Ø150 / Ø160					
External diameter condensate discharge [“]	3/4					
Weight [kg]	37					
Filter class	G4					
Fan setting (factory setting) - control unit					Max.	
4-way switch		1	2	3		
Ventilation capacity [m³/h]	50	100	150	225	300	
Permissible resistance ducts system [Pa]	3 - 6	11 - 26	25 - 58	56 - 129	100 - 230	
Rated power (excl. optional preheater) [W]	8,7 - 9,1	14,9 - 16,3	25,7 - 31,7	57,8 - 77,8	116,1 - 162,9	
Rated current (excl. optional preheater) [A]	0,10	0,15 - 0,17	0,25 - 0,29	0,50 - 0,66	0,95 - 1,34	
Rated power (incl. optional preheater) [W]	6					
Cos φ	0,39	0,42	0,45 - 0,47	0,50 - 0,51	0,53	

Packaging unit

Packaging unit per pallet
3

Warranty period

2 years on parts and 5 years on the heat exchanger.

Sound power

Sound power Sky 300		100		150		225			300	
Ventilation capacity [m³/h]										
Sound power level L _w (A)	Static pressure [Pa]	17	40	38	80	84	100	160	150	178
	Housing emission [dB(A)]	29	30	37	40	46	46	47	53	53
	Duct “from dwelling” [dB(A)]	32	32	41	43	49	49	50	55	55
	Duct “to dwelling” [dB(A)]	43	44	51	53	60	61	62	69	68

In practice, the value may deviate 1 dB(A) as a result of measuring tolerances.

Fan graph

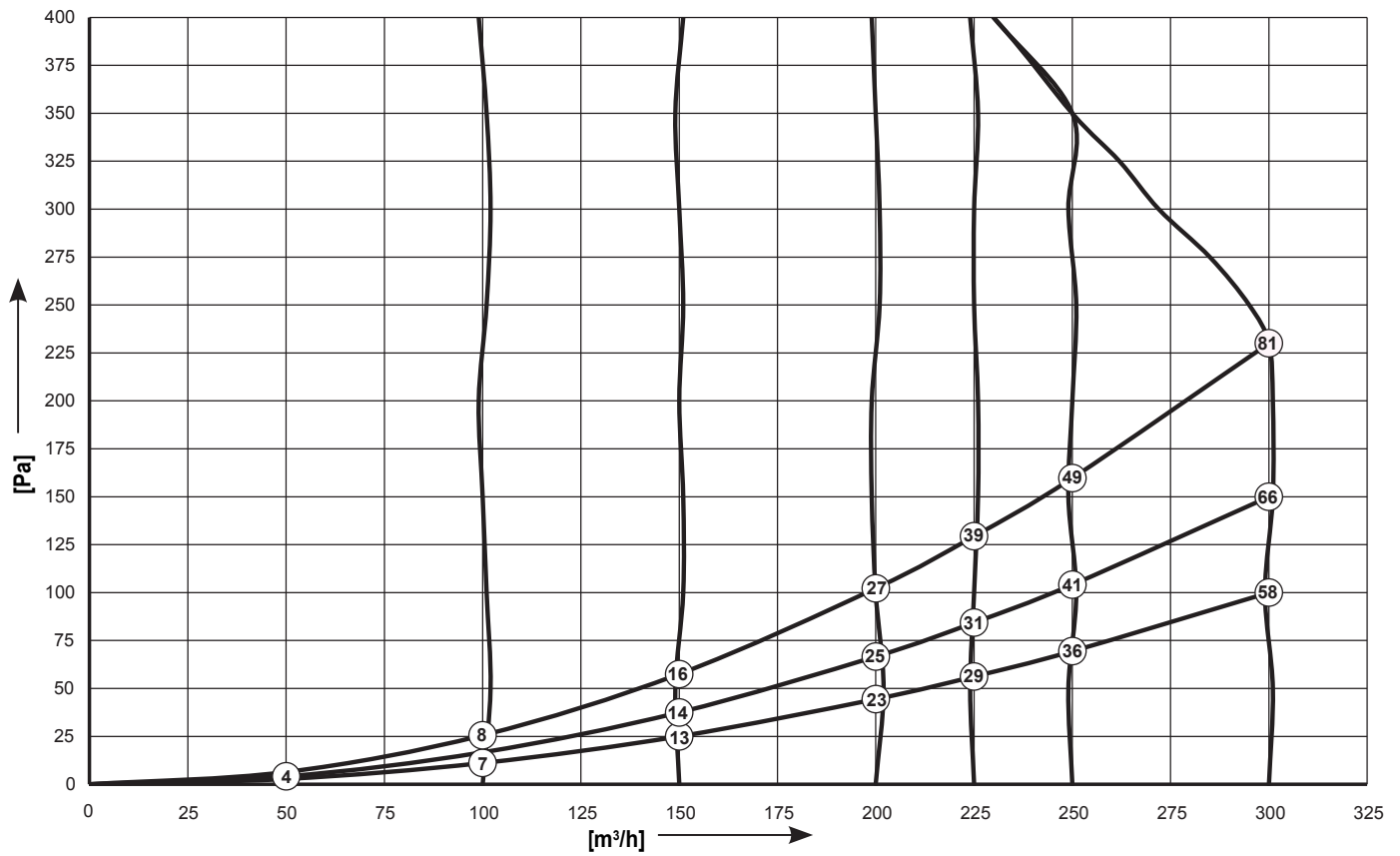



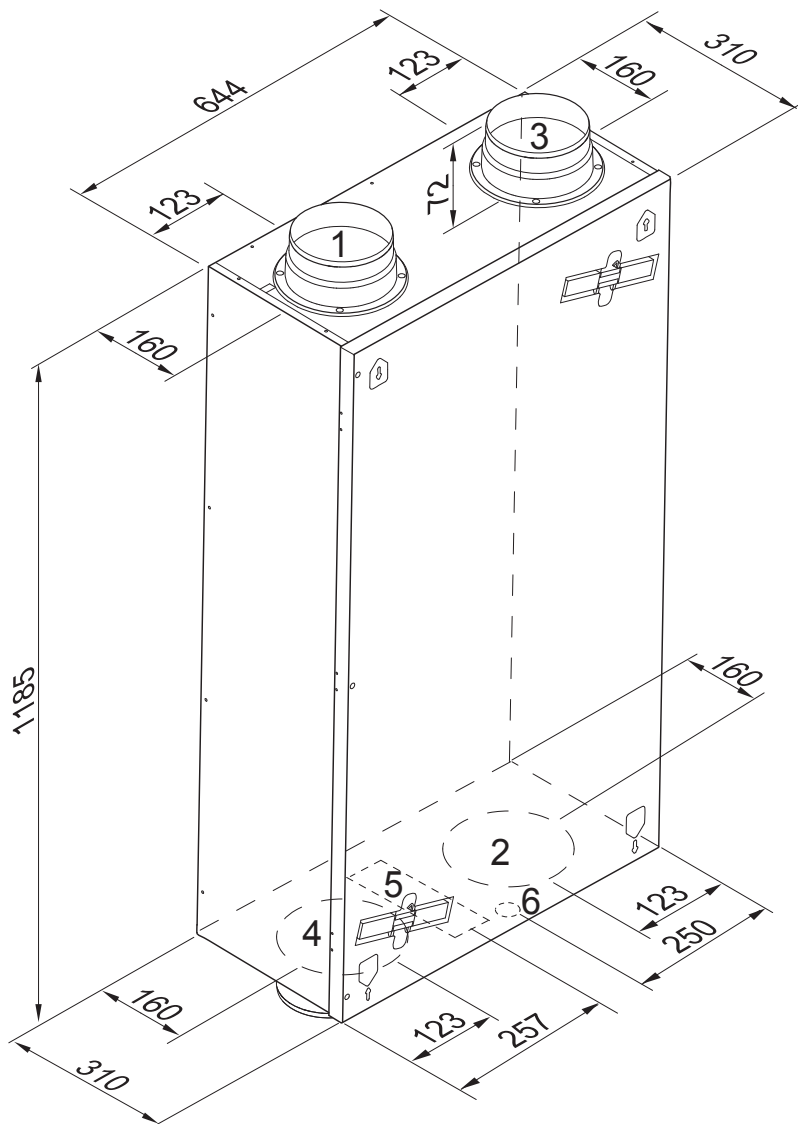

Fan graph Renovent Sky 300

Note: The value stated in the circle is the capacity per fan (in Watt)

Connections and dimensions Renovent Sky 300



- ① = To dwelling 
- ② = To atmosphere 
- ③ = From dwelling 
- ④ = From atmosphere 
- ⑤ = Electric connections
- ⑥ = Connection condensate discharge

Service parts

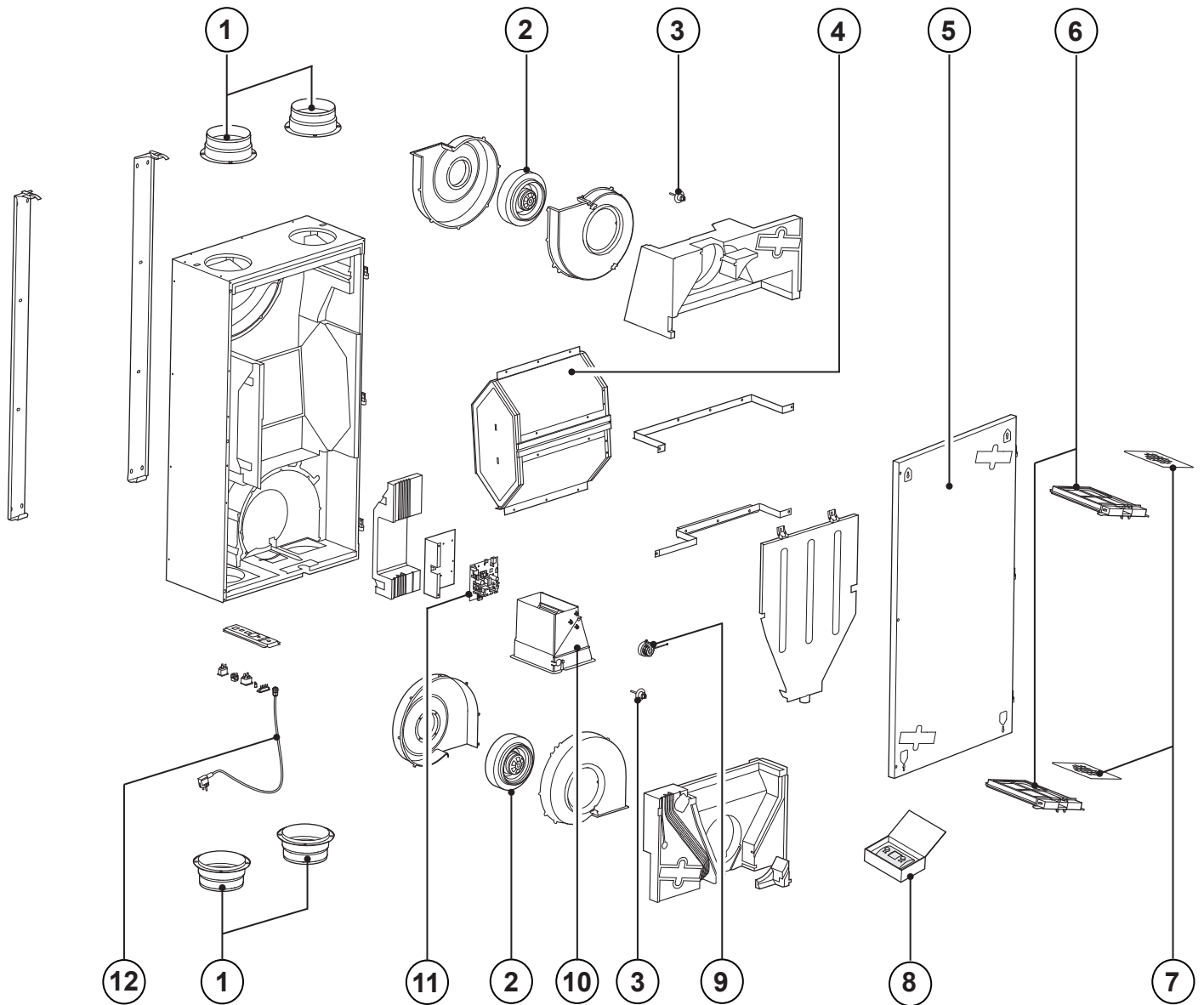

		Code
1	Air duct connections (4 pcs)	532004
2	Fan (1 pcs)	532003
3	Temperature sensor (1 pcs)	531775
4	Heat exchanger	532006
5	Front cover with hinges	532007
6	Filter holder set (2 pieces)	532005
7	Filter kit 2x G4 filter (standard version)	532000
	Filter kit 1x F7 filter	532001
	Filter kit 1x G4 & 1x F7	532002

		Code
8	Control unit	510490
9	Motor bypass valve	531778
10	Bypass valve	531779
11	Control board (Plus version) When replacing, note the correct dip switch settings.	531780
12	Cable with power plug 230 volt *	531978

* The mains cable has a print connector.
 When replacing it, always order a replacement mains cable Brink
To avoid dangerous situations, a damaged mains should only be replaced by a qualified person!

DIBt: Renovent Sky 300



Deutsches Institut für Bautechnik

Zulassungsstelle für Bauprodukte und Bauarten
Deutsches Institut für Bautechnik
 Eine vom Bund und den Ländern gemeinsames getragenes Institut des öffentlichen Rechts
 Mitglied der EOTA, der LEA/CE und der VFA/CE

Datum: 09.07.2013 Geschäftszeichen: III 68-1.51.3-27/12

Zulassungsnummer:
Z-61.3-281

Antragsteller:
Brink Climate Systems B.V.
R.D. Biggelaars 3
7951 DA Staphorst
NIEDERLANDE

Geltungsdauer:
vom: 9. Juli 2013
bis: 9. Juli 2016

Zulassungsgegenstand:
Zentrales Lüftungsgerät mit Wärmerückgewinnung vom Typ "Renovent Sky 300"



Deutsches Institut für Bautechnik

Der oben genannte Zulassungsgegenstand wird hiermit allgemein bauaufsichtlich zugelassen.
 Diese allgemeine bauaufsichtliche Zulassung umfasst neun Seiten und sechs Anlagen.



DIBt | Kolonnenstraße 30 | D-10829 Berlin | Tel.: +49 30 787330-0 | Fax: +49 30 787330-220 | E-Mail: dibt@dibt.de | www.dibt.de

EN 308/EN 13141-7: Renovent Sky 300



TNO innovation for life

Technical Sciences
Laan van Westenenk 501
3734 DT Apeldoorn
Postbus 342
7300 AH Apeldoorn
www.tno.nl
T +31 88 866 22 12
F +31 88 866 22 48
infodesk@tno.nl

Declaration of Conformity according to EN 13141-7:2004 / EN308

TNO 2012 M10384A
Determination of the energetic efficiency of the energy recovery appliance "Renovent Sky 300"
Test report in accordance with EN 13141-7:2004 / EN308

Date: May 2013
 Author(s): H.A.J. Hamink
 Sponsor: Brink Climate Systems BV
 R.D. Biggelaars 3
 7951 DA Staphorst
 Project number: 060.01122
 Keywords: heat recovery efficiency

All rights reserved.
 No part of this publication may be reproduced and/or published by print, photoprint, microfilm or any other means without the previous written consent of TNO.
 In case this report was drafted on instructions, the rights and obligations of contracting parties are subject to either the General Terms and Conditions for commissions to TNO, or the relevant agreement concluded between the contracting parties. Submitting the report for inspection to parties who have a direct interest is permitted.
 © 2013 TNO

NEN 5138: Renovent Sky 300



TNO innovation for life

Technical Sciences
Laan van Westenenk 501
7334 DT Apeldoorn
Postbus 342
7300 AH Apeldoorn
www.tno.nl
T +31 88 866 22 12
F +31 88 866 22 48
infodesk@tno.nl

Verklaring conform norm
060-APD-2012-00140
Bepaling van het energetische rendement van het warmterugwinapparaat "Renovent Sky 300"
Meetbrief volgens NEN 5138-2004

Datum: Juli 2012
 Auteur(s): H.A.J. Hamink
 Opdrachtgever: Brink Climate Systems BV
 R.D. Biggelaars 3
 7951 DA Staphorst
 Projectnummer: 054.01894/01.01
 Trefwoorden: warmterugwinning rendement

Alle rechten voorbehouden.
 Niets uit deze uitgave mag worden vermenigvuldigd en/of openbaar gemaakt door middel van druk, fotokopie, microfilm of op welke andere wijze dan ook, zonder voorafgaande toestemming van TNO.
 Indien dit rapport in opdracht werd uitgebracht, wordt voor de rechten en verplichtingen van opdrachtgever en opdrachtnemer verwezen naar de Algemene Voorwaarden voor opdrachten aan TNO, dan wel de betreffende terzake tussen de partijen gesloten overeenkomst.
 Het ter inzage geven van het TNO-rapport aan direct belanghebbenden is toegestaan.
 © 2012 TNO

Passive House Certificate: Renovent Sky 300



Passive House Institute
Dr. Wolfgang Feist
64283 Darmstadt
GERMANY

Certificate
Certified Passive House Component
 For cool, temperate climates, valid until 31 December 2013

Category: **Heat recovery unit**
 Manufacturer: **Brink Climate Systems B.V.**
7951 – DA Staphorst, NETHERLANDS
 Product name: **Renovent Sky 300**

This certificate was awarded based on the following criteria:

Thermal comfort	$\theta_{\text{supply air}} \geq 16.5 \text{ }^\circ\text{C}$ at $\theta_{\text{outdoor air}} = -10 \text{ }^\circ\text{C}$
Effective heat recovery rate	$\eta_{\text{HR,eff}} \geq 75 \%$
Electric power consumption	$P_{\text{el}} = 0.45 \text{ Wh/m}^3$
Airtightness	Interior and exterior air leakage rates less than 3 % of nominal air flow rate
Balancing and adjustability	Air flow balancing possible: yes Automated air flow balancing: yes
Sound insulation	Sound pressure level $L_p \leq 35 \text{ dB(A)}$ based on a 4 m ² equivalent absorption area not met Here $L_p = 47.8 \text{ dB(A)}$ Unit should be installed so that it is acoustically separated from living areas
Indoor air quality	Outdoor air filter at least F7 Extract air filter at least G4
Frost protection	Frost protection for the heat exchanger with continuous fresh air supply down to $\theta_{\text{outdoor air}} = -15 \text{ }^\circ\text{C}$

Certified for air flow rates of
66 – 226 m³/h

 $\eta_{\text{HR,eff}}$
85 %

Electric power consumption
0.31 Wh/m³



CERTIFIED

Further information can be found in the appendix of this certificate.

SAP-Appendix-Q: Renovent Sky 300

Standard Assessment Procedure – Appendix Q MVHR Product Data 10/10/2012

SAP Appendix Q Testing Results
Central mechanical supply and exhaust ventilation system packages with heat recovery used in a single dwelling

Brand Name	Brink		
Model	Renovent Sky 300		
Model Qualifier (if applicable)			
Current Manufacturer and Contact Details	Name	Brink Climate Systems B.V.	
	Address	Postbus 11 NL-7850 AA Staphorst Holland	
	Telephone	00 31 522 46 99 44	
	Website	http://www.brinkclimatesystems.nl	
Original Manufacturer (if different)			
First Year of Manufacture	2012		
Last Year of Manufacture			
Testing Body	BRE		
Date of test	13/09/2012		
Serial Number of Product Tested	422004121601		
MVHR to outside grille duct types and size	150 & 125mm diameter rigid plastic & 200mm rectangular rigid plastic		
Duct types and sizes used for supply and exhaust	150 & 125mm diameter rigid plastic & 200mm rectangular rigid plastic		

Results of leakage tests

Table Q1

	Internal	Pass
		Pass
	External	Pass

1 of 3

Declaration of Conformity Renovent Sky 300

CONFORMITEITSVERKLARING

Fabrikant: Brink Climate Systems B.V.
 Adres: R.D. Biegelstraat 3
7954 DA Staphorst, Nederland
 Produkt: Warmteterugwinstestel type:
Renovent Sky 300
Renovent Sky 300 Plus

Het hierboven beschreven product voldoet van de volgende richtlijnen:
 2006/95/EC (laagspanningsrichtlijn)
 2004/108/EC (EMC-richtlijn)
 RoHS 2002/95/EC (stoffenrichtlijn)

Het product is voorzien van het CE-label: **CE**

Staphorst, 05-01-12

 W. Hijmisen,
 directeur

DECLARATION OF CONFORMITY

Manufacturers: Brink Climate Systems B.V.
 Address: R.D. Biegelstraat 3
7954 DA Staphorst, The Netherlands
 Product: Heat recovery unit type:
Renovent Sky 300
Renovent Sky 300 Plus

The product described above complies with the following directives:
 2006/95/EC (low voltage directive)
 2004/108/EC (EMC directive)
 RoHS 2002/95/EC (substances directive)

The product bears the CE label: **CE**

Staphorst, 05-01-12

 W. Hijmisen,
 managing director

94 Renovent Sky 300 Rev D

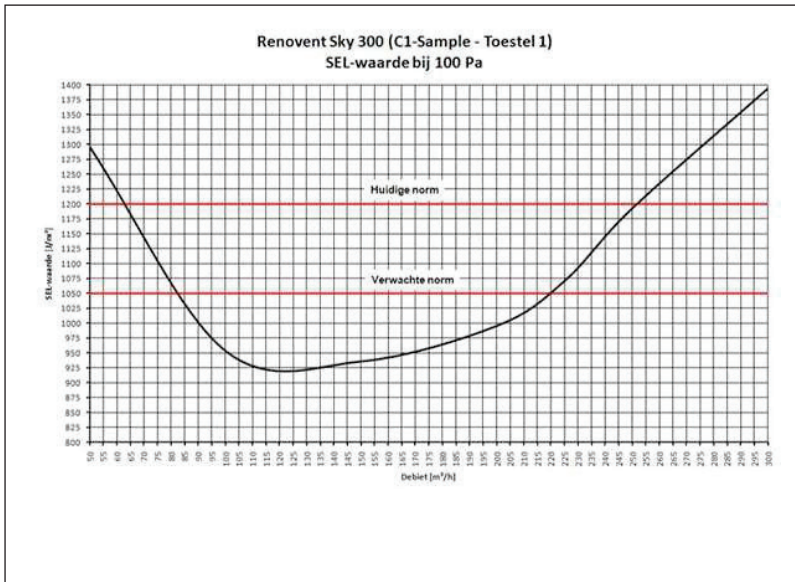
Renovent Sky 300 - SEL-waarde 100Pa



Modifications reserved

Brink Climate Systems B. V. continuously strives after improvement of products and reserves the right to change the specifications without prior notice.



BRINK CLIMATE SYSTEMS B.V.

P.O. Box 11 7950 AA Staphorst
Tel. +31 (0) 522 46 99 44
Fax +31 (0) 522 46 94 00
info@brinkclimatesystems.nl
www.brinkclimatesystems.nl